

KENWOOD

CD-RECEIVER

KDC-MP246

KDC-MP146

KDC-MP3046

KDC-MP2046

KDC-MP1046

INSTRUCTION MANUAL

Kenwood Corporation



Contents

Before Use	3	Appendix	15
Basic Operations	4	Accessories/Installation Procedure	16
Before Using		Connecting Wires to Terminals	17
Common Operation		Installation/Removing the Unit	18
Playing Music		Troubleshooting Guide	19
Listening Radio		Specifications	20
General	6		
Removing the Faceplate			
Muting Volume upon Reception of Phone Call			
Display Indicator			
Text Display Selection			
Function Setting	8		
<SETTINGS>			
<INITIAL SET>			
<DEMO MODE>			
<AUDIO CONTROL>			
Music Disc/Audio File Operation	12		
Play Function			
Music Search			
Direct Music Search			
Tuner Operation	13		
Frequency Step Setting			
No remote control Included	14		

Before Use

▲WARNING

To prevent injury or fire, take the following precautions:

- To prevent a short circuit, never put or leave any metallic objects (such as coins or metal tools) inside the unit.

Before using this unit for the first time

This unit is initially set on the Demonstration mode. When using this unit for the first time, cancel the Demonstration mode. Refer to <Exit of the Demonstration Mode> (page 4).

How to reset your unit

- If the unit fails to operate properly, press the Reset button. The unit returns to factory settings when the Reset button is pressed.
 1. Release the faceplate lock so that it can be removed. Refer to <Removing the Faceplate> (page 6)
 2. Press the Reset button and reattaching the faceplate.

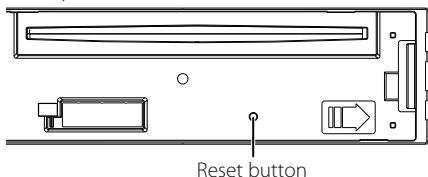

Cleaning the Unit

If the faceplate of this unit is stained, wipe it with a dry soft cloth such as a silicon cloth.

If the faceplate is stained badly, wipe the stain off with a cloth moistened with neutral cleaner, then wipe it again with a clean soft dry cloth.



- Applying spray cleaner directly to the unit may affect its mechanical parts. Wiping the faceplate with a hard cloth or using a volatile liquid such as thinner or alcohol may scratch the surface or erases characters.

About the Terminals of the Unit and Faceplate

- To prevent deterioration, do not touch the terminals of the unit and faceplate with your fingers.
- If the terminals on the unit or faceplate get dirty, wipe them with a clean soft dry cloth.

Lens Fogging

When you turn on the car heater in cold weather, dew or condensation may form on the lens in the

CD player of the unit. Called lens fogging, this condensation on the lens may not allow CDs to play. In such a situation, remove the disc and wait for the condensation to evaporate. If the unit still does not operate normally after a while, consult your Kenwood dealer.

Notes

- If you experience problems during installation, consult your Kenwood dealer.
- When you purchase optional accessories, check with your Kenwood dealer to make sure that they work with your model and in your area.
- The characters which can be displayed by this unit are A-Z 0-9 @ " ' ` % & * + = , . / \ < > [] () ; : ^ - { } | ~ .
- The illustrations of the display and the panel appearing in this manual are examples used to explain more clearly how the controls are used. Therefore, what appears on the display in the illustrations may differ from what appears on the display on the actual equipment, and some of the illustrations on the display may be inapplicable.

Handling CDs

- Do not touch the recording surface of the CD.
- Do not stick tape etc. on the CD, or use a CD with tape stuck on it.
- Do not use disc type accessories.
- Clean from the center of the disc and move outward.
- When removing CDs from this unit, pull them out horizontally.
- If the CD center hole or outside rim has burrs, use the CD only after removing the burrs with a ballpoint pen etc.

CDs that cannot be used

- CDs that are not round cannot be used.
- CDs with coloring on the recording surface or CDs that are dirty cannot be used.
- This unit can only play the CDs with

This unit may not correctly play discs which do not have the mark.

- You cannot play a CD-R or CD-RW that has not been finalized. (For the finalization process refer to your CD-R/CD-RW writing software, and your CD-R/CD-RW recorder instruction manual.)
- 3 inch CD cannot be used. Attempt to insert using an adapter can cause malfunction.

Basic Operations

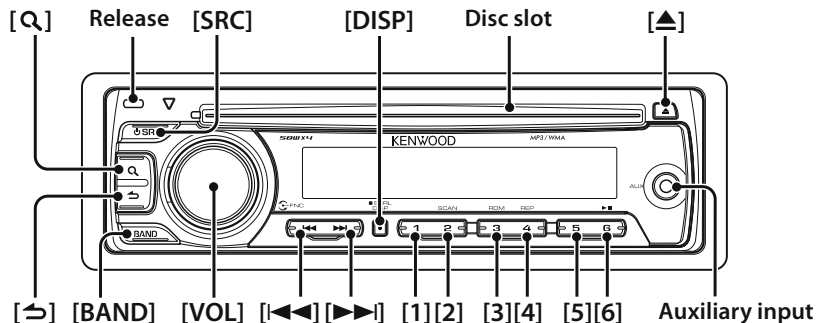

Before Using

Exit of the Demonstration Mode

Turn off the demonstration mode when you use it for the first time after installation.

- 1 Press the [VOL] knob to quit the demonstration mode when the messages "CANCEL DEMO", "PRESS", "VOLUME KNOB" are displayed (approx. 15 seconds).
- 2 Select "YES" and press the [VOL] knob. When "NO" is selected, turn the [VOL] knob.



- Demonstration mode can also be cancelled in "DEMO MODE" of <Function Setting> (page 8).

Adjusting the Clock

- 1 Press the [DISP] button several times until clock display ("CLOCK") appears.
- 2 Keep pressing the [DISP] button until the hour display blinks.
- 3 Turn the [VOL] knob to adjust the hour.
- 4 Press the [VOL] knob to finish the hour adjusting. The minute display blinks.
- 5 Turn the [VOL] knob to adjust the minute.
- 6 Press the [VOL] knob to finish the minute adjusting.

Common Operation

Power and source select

Turns the power ON by pressing the [SRC] button.

When power is ON, pressing the [SRC] button switches among playable sources in the following order:

Tuner ("TUNER") → CD ("CD") → Auxiliary Input ("AUX") → Standby ("STANDBY") → Tuner ("TUNER")

Keeping pressing the [SRC] button for at least 1 second turns the power OFF.



- The source "CD" can be selected when each source is ready to play.

Volume

Turning the [VOL] knob adjusts the sound volume.

Clock display and Display scroll

Pressing the [DISP] button selects the display mode.

Refer to <Text Display Selection> (page 7).

Keeping pressing the [DISP] button scrolls the display.

Auxiliary input

Portable audio device can be connected with the stereo mini-plug (3.5 mm ø).

Playing Music

Playing Disc

Insert a disc into the disc slot.
When inserted, the source is switched automatically and a song starts playing.

Folder select

Pressing the [BAND] button switches a folder.

Song select

Pressing the [◀◀] or [▶▶] button selects a song (track or file).
Fast reverses or forwards the music while pressing the [◀◀] or [▶▶] button.
(No sound is output while playing audio file.)

Pause and play

Pressing the [6] button pauses or resumes playing a song (track or file).

Removing Disc

Pressing the [▲] button ejects a disc.



- For the playable audio files, see <About Audio file> (page 15).

Listening Radio

Select Tuner source

Pressing the [SRC] button several times switches the source to "TUNER".

Band select

Pressing the [BAND] button switches the receiving band (FM1, FM2, FM3, MW, SW1, SW2).

Station select

Pressing the [◀◀] or [▶▶] button selects the station.

Station memory

Pressing the [1] – [6] button recalls the memorized station.
Keeping pressing the [1] – [6] button for at least 2 seconds memorizes the station currently selected.



- Details of the station selecting in operation are set in the "SEEK MODE" of <Function Setting> (page 8).
- Receivable stations can be automatically memorized. See "AUTO MEMORY" of <Function Setting> (page 8).
- Up to 6 each stations can be memorized to the [1] – [6] button in each band (FM1, FM2, FM3, MW, SW1, SW2).
- Up to 6 stations with a different band (FM/AM) can be memorized to the [1] – [6] button according to the setting of "PRESET TYPE" of <Function Setting> (page 8).

General

Removing the Faceplate

The faceplate of the unit can be detached and taken with you, helping to deter theft.

Detach the faceplate

Press the Release button.

Reattaching the Faceplate

Refer to the following diagram when reattaching the faceplate.

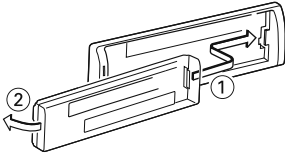

- After pressing the Release button, detach the faceplate immediately. If the faceplate is left attached, it can fall due to vibration and so on.
- The faceplate is a precision piece of equipment and can be damaged by shocks or jolts.
- Keep the faceplate in its faceplate case while detached. (KDC-MP246/ KDC-MP146/ KDC-MP2046 only)
- Do not place the faceplate (and the faceplate case) in areas exposed to direct sunlight, excessive heat or humidity. Also avoid places with too much dust or the possibility of water splashing.

Muting Volume upon Reception of Phone Call

The audio system automatically mutes when a call comes in.

When a call comes in

“CALL” is displayed.

The audio system pauses.

Listening to the audio during a call

Press the [SRC] button.

The “CALL” display disappears and the audio system comes back ON.

When the call ends

Hang up the phone.

The “CALL” display disappears and the audio system comes back ON.



- To use the TEL Mute feature, you need to hook up the MUTE wire to your telephone using a commercial telephone accessory. Refer to <Connecting Wires to Terminals> (page 17).

Display Indicator

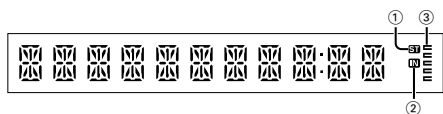

- ① “ST” indicator: Lights when a stereo broadcast is received.
- ② “IN” indicator: Lights when a disc is in the unit.
- ③ “==” indicator: Shows the image indicating the operating state of each source or the setting of Audio Control.

Text Display Selection

Changing displayed information on each source following;

In Tuner source

Information	Display
Frequency	“FREQUENCY”
Clock	“CLOCK”

In CD source

Information	Display
Disc title	“DISC TITLE”
Track title	“TRACK TITLE”
Play time & Track number	“P-TIME”
Clock	“CLOCK”

In Audio file source

Information	Display
Music title & Artist name	“TITLE”
Album name & Artist name	“ALBUM”
Folder name	“FOLDER NAME”
File name	“FILE NAME”
Play time & Music number	“P-TIME”
Clock	“CLOCK”

In Standby/ Auxiliary input source

Information	Display
Source name	“SOURCE NAME”
Clock	“CLOCK”

Select the text

Press the [DISP] button.



- When you select the clock display, the display setting of each source will be changed to the clock display.
- If the selected display item does not have any information, alternative information is displayed.

Function Setting

Perform configuration for this unit. You can set up the following functions.

1 Select a source

Press the [SRC] button.

Items to be displayed vary depending on the selected source. Refer to the function list shown later.

2 Enter Function Setting mode

Press the [VOL] knob.

"FUNCTION" is displayed.

3 Select the Function item

Turn the [VOL] knob to display your desired item, and then press the [VOL] knob.

Repeat the above operation to select the function item to set.

Pressing the [↵] button allows you to go back to the previous item.

4 Set the Function item

Turn the [VOL] knob to select your desired setting, and then press the [VOL] knob.

5 Exit Function Setting mode

Press the [↵] button for at least 1 second.

Function item

Legend :

No Function name: "Function name displayed on this unit" ▶ "Setting 1"*, "Setting 2"...

The function related to the selected function item is described. For where it appears, refer to the **No** given in the function list.



- The setting marked with * is a factory setting.
- The function marked with *1 is supported only by the KDC-MP246/ KDC-MP3046/ KDC-MP2046/ KDC-MP146.

<SETTINGS>

1 Clock Adjust: "CLOCK ADJ"

Sets the clock

1. Turn the [VOL] knob to adjust the hour.
2. Press the [VOL] knob to finish the hour adjusting. The minute display blinks.
3. Turn the [VOL] knob to adjust the minute.
4. Press the [VOL] knob to finish the minute adjusting.

2 Dimmer: "DIMMER SET" ▶ "ON", "OFF"

Adjusts the brightness of the display according to the surrounding illumination.

3 Text Scroll: "TEXT SCROLL" ▶ "AUTO"*, "MANUAL"

Scrolls the CD and audio file text display. Selecting AUTO scrolls them automatically.

4 Local Seek: "LOCAL SEEK" ▶ "ON", "OFF"

Only stations whose reception is good are searched in auto seek tuning. (AM only)

5 Seek Mode: "SEEK MODE" ▶ "AUTO1"*, "AUTO2", "MANUAL"

Selects the tuning mode of the radio.

Tuning mode	Display	Operation
Auto seek	"AUTO1"	Automatic search for a station.
Preset station seek	"AUTO2"	Search in order of the stations in the Preset memory.
Manual	"MANUAL"	Normal manual tuning control.

6 Auto Memory: "AUTO MEMORY"

Memorizes six stations with good reception automatically.

Selecting "YES" and then pressing the [VOL] knob starts the auto memory operation.



- This setting can be made when "TYPE NORM" is selected for the <Mixed Preset Memory Switching> item.

7 Monaural Reception: "MONO SET" ▶

"ON", "OFF"

You can reduce the noise when stereo broadcasts are received as monaural. (FM only)

8 Name Set: "AUX NAME" ▶ "AUX"*, "DVD",

"PORTABLE", "GAME", "VIDEO", "TV"

Sets the display when switched to AUX source.

<INITIAL SET>

9 Mixed Preset Memory Switching: "PRESET TYPE" ▶ "TYPE NORM"*, "TYPE MIX"

"TYPE NORM":

1 station can be assigned to 1 preset button in each of 6 bands (FM1, FM2, FM3, MW, SW1 and SW2), i.e., a total of 36 stations (6 stations x 6 bands) can be preset.

"TYPE MIX":

A total of 6 stations can be assigned to a total of 6 preset buttons regardless of band (FM1, FM2, FM3 MW, SW1, and SW2). You can recall a preset station without switching between bands.

10 Beep: "KEY BEEP" ▶ "ON"*, "OFF"

Setting the operation check sound (beep sound) ON/OFF.

11 TDF(Theft Deterrent Faceplate) Attention Alarm: "TDF ALARM" ▶ "ON", "OFF"

Informs you by sound that you forgot to detach the faceplate when ACC is set to OFF.

12 Built in AUX: "BUILTIN AUX" ►

"ON1"*,"ON2","OFF"

When this is set to ON, AUX source can be selected.

ON1: Outputs the sound of external unit connected to the AUX terminal when switched to AUX source.

ON2: Activates the attenuator function when turning on the power with AUX source selected.

Turn off the attenuator function when listening to output from external unit. This prevents the noise when no external unit is connected to AUX terminal.

OFF: Disables the selection of AUX source. Set to OFF when not using the AUX terminal.

13 CD READ: "CD READ" ► "1"*,"2"

Sets the method for reading CD.

When unable to play special format CD, set this function to "2" to force playing. Note that some music CD may be unplayable even when set to "2".

In addition, audio files cannot be played when set to "2". Normally, keep this set to "1".

1 : Automatically distinguishes between audio file disc and music CD when playing disc.

2 : Forces playing as music CD.

14 Switching Preout*1: "SWITCH PRE" ►

"REAR"*,"SUB-W"

Switches the preout between rear output ("REAR") and subwoofer output ("SUB-W").

15 Speaker Select: "SP SELECT" ► "OFF"*,"5/4","6*9/6","OEM"

Fine-tuning so that the System Q value is optimal when setting the speaker type as follows;

Speaker type	Display
OFF	"SP OFF"
For 5 & 4 in. speaker	"SP 5/4"
For 6 & 6x9 in. speaker	"SP 6*9/6"
For the OEM speaker	"SP OEM"

16 Firmware Upgrade: "F/W UP xx.xx" ►

Upgrades the firmware.

Selecting "YES" and then pressing [VOL] knob starts upgrading the firmware.



- For how to update the firmware, access our web site. <http://www.kenwood.com/cs/ce/>

<DEMO MODE>

17 Demo Mode: "DEMO MODE" ► "ON"*,"OFF"

Specifies whether to enable demonstration.

<AUDIO CONTROL>

18 Subwoofer output*1: "SUB-W SET" ► "ON"*,"OFF"



- This setting can be made when "SUB-W" is selected for the <Switching Preout> item.

19 Bass Boost: "BASS BOOST" ► "LV1"*,"LV2","OFF"

20 System Q: "SYSTEM Q" ► "NATURAL"*,"ROCK","POPS","EASY","TOP 40","JAZZ","GAME","USER"

Switches between the following preset equalizer curves; Natural, Rock, Pops, Easy, Top 40, Jazz, Game, User setting



- "USER": This appears when Bass level, Middle level, and Treble level are adjusted. When the System Q setting is changed, the Bass, Middle, and Treble set replace the System Q values.

21 Bass level adjust: "BASS LEVEL" ► "-8" - "+8"

22 Middle level adjust: "MID LEVEL" ► "-8" - "+8"

23 Treble level adjust: "TRE LEVEL" ► "-8" - "+8"



- **21 - 23** : Source tone memory: Puts the set up value in the memory per source.

24 Balance: "BALANCE" ► "L 15" - "R 15"

25 Fader: "FADER" ► "R 15" - "F 15"

26 Subwoofer level adjust: "SUB-W LEVEL" ►

"- 15" - "+ 15"

27 Subwoofer Low Pass Filter: "LPF SUB-W" ►

"85","120","160","THROUGH"(OFF)*

28 Subwoofer Phase: "SUB-W PHASE" ►

"REV"(180°),"NORM"(0°)*



- **26 - 28** : These adjustments can be made when "ON" is selected for the <Subwoofer output> item.
- **28** : This adjustment can be made when a setting other than "THROUGH" is selected for the <Subwoofer Low Pass Filter> item.

29 Supreme: "SUPREME SET" ► "ON"*,"OFF"

Technology to extrapolate and supplement with proprietary algorithm, the high-frequency range that is cut off when encoding at low bit rate (less than 128Kbps, Sampling frequency is 44.1kHz).

Function Setting

Supplementing is optimized by compression format (MP3 or WMA) and processed according to bit rate.

The effect is negligible with music that is encoded at high bit rate, variable bit rate or has minimal high frequency range.

Can be set while Audio file source of CD.

30 Volume offset: "VOL OFFSET" > "-8" - "±0"
(When in AUX source: "-8" - "+8")

Sets each source's volume as a difference from the basic volume.

Function List

Function items appearing during standby

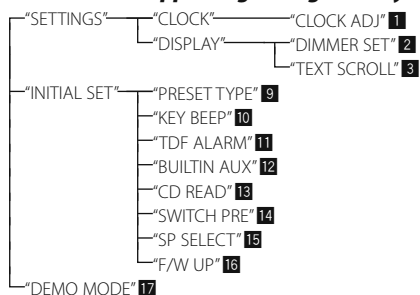

Function items appearing when the tuner source is selected

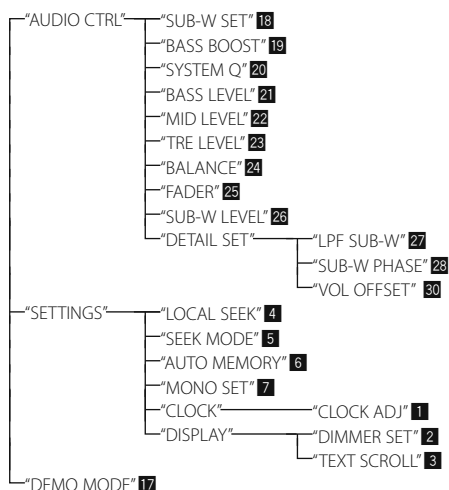

Function items appearing when the CD & audio file source is selected

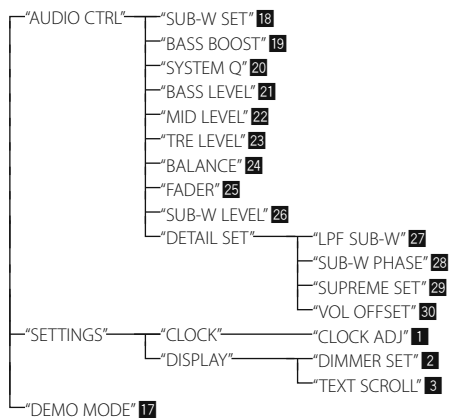

Function items appearing when an AUX source is selected

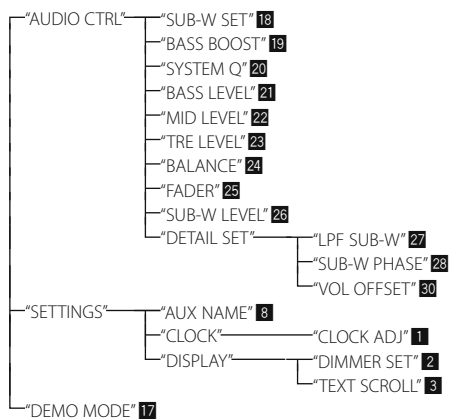

Music Disc/Audio File Operation

Play Function

Repeat play

Press the [4] button.

Switches between Track Repeat ("TRAC REPEAT") and OFF ("REPEAT OFF") when pressed while playing a CD.

Switches between File Repeat ("FILE REPEAT"), Folder Repeat ("FOLD REPEAT"), and OFF ("REPEAT OFF") when pressed while playing an audio file.

Random play

Press the [3] button.

Randomly plays the music in the disc or folder.

When Random Play is turned on, "DISC RANDOM"/"FOLD RANDOM" is displayed.

Pressing this button again cancels the Random play.

Scan play

Press the [2] button.

Successively plays the intro of the music in the disc or folder.

When Scan Play is turned on, "TRAC SCAN"/"FILE SCAN" is displayed.

Pressing this button again plays songs in the normal mode starting with the song being played now.

Music Search

Selecting the music you want to listen to from the device or media being played now.

1 Enter Music Search mode

Press the [Q] button.

"SEARCH" is displayed.

Displays the current Audio file name.

2 Search for music

Audio file

Operation type	Operation
Movement between folders/files	Turn the [VOL] knob.
Selection of folder/file	Press the [VOL] knob.
Return to previous folder	Press the [↩] button.
Return to root folder	Press the [BAND] button.

"<" or ">" beside the displayed folder name indicates that this folder is preceded or followed by another folder.

CD source

Operation type	Operation
Movement between track	Turn the [VOL] knob.
Selection of track	Press the [VOL] knob.
Return to first track	Press the [BAND] button before selecting a track.

Cancelling the Music Search mode

Press the [↩] button for at least 1 second.

Function of KDC-MP246/ KDC-MP146/ KDC-MP3046/ KDC-MP2046 with remote control

Direct Music Search

Searches the music by entering the track number.

1 Enter Direct Music Search mode

Press the [DIRECT] button on the remote control.

"-- --" is displayed.

2 Enter the music number

Press the number buttons on the remote control.

3 Search the station

Press the [◀◀] or [▶▶] button.

Cancelling Direct Music Search

Press the [↩] button on the remote control.



- Direct Music Search cannot be performed during Random play or scan play.

Tuner Operation

Frequency Step Setting

Changing the tuning frequency step.

The original setting is FM band 50 kHz, MW band 9 kHz.

1 Turn the power OFF

Press the [SRC] button for at least 1 second.

2 Switch the frequency step

While pressing the [1] and [5] buttons, press the [SRC] button.

Release your fingers from the button after the display appears.

The frequency step changes to FM band 200 kHz, and MW band 10 kHz.



- When the same operation is repeated, the frequency step returns to the original setting.
- When the frequency step is changed, the frequencies in the memory are deleted.

Remote Control not Included



Appendix

About Audio file

- **Playable Audio file**

MP3 (.mp3), WMA (.wma)

- **Playable disc media**

CD-R/RW/ROM

- **Playable disc file format**

ISO 9660 Level 1/2, Joliet, Romeo, Long file name.

Although the audio files are complied with the standards listed above, the play maybe impossible depending on the types or conditions of media.

- **Playing order of the Audio file**

In the example of folder/file tree shown below, the files are played in the order from ① to ⑩.

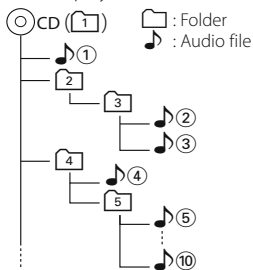

An online manual about audio files is put on the site, www.kenwood.com/cs/ce/audiofile/. On this online manual, detailed information and notes which are not written in this manual are provided. Make sure to read through the online manual as well.

The marking of products using lasers (Except for some areas)



The label is attached to the chassis/case and says that the component uses laser beams that have been classified as Class 1. It means that the unit is utilizing laser beams that are of a weaker class. There is no danger of hazardous radiation outside the unit.

Accessories/Installation Procedure

Accessories

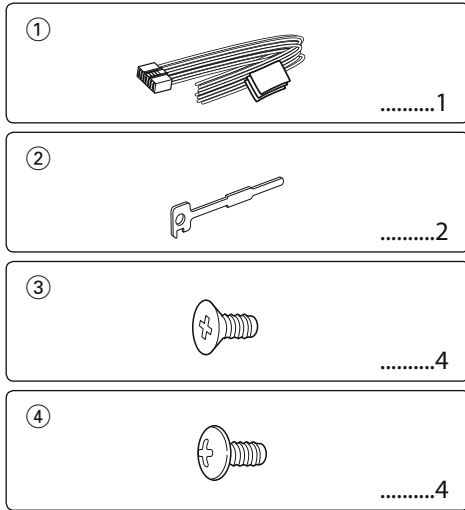

Installation Procedure

1. To prevent a short circuit, remove the key from the ignition and disconnect the \ominus battery.
2. Make the proper input and output wire connections for each unit.
3. Connect the speaker wires of the wiring harness.
4. Connect the wiring harness wires in the following order: ground, battery, ignition.
5. Connect the wiring harness connector to the unit.
6. Install the unit in your car.
7. Reconnect the \ominus battery.
8. Press the reset button.

▲WARNING

If you connect the ignition wire (red) and the battery wire (yellow) to the car chassis (ground), you may cause a short circuit, that in turn may start a fire. Always connect those wires to the power source running through the fuse box.



- Mounting and wiring this product requires skills and experience. For safety's sake, leave the mounting and wiring work to professionals.
- Make sure to ground the unit to a negative 12V DC power supply.
- Do not install the unit in a spot exposed to direct sunlight or excessive heat or humidity. Also avoid places with too much dust or the possibility of water splashing.
- Do not use your own screws. Use only the screws provided.

- If you use the wrong screws, you could damage the unit.
- If the power is not turned ON ("PROTECT" is displayed), the speaker wire may have a short-circuit or touched the chassis of the vehicle and the protection function may have been activated. Therefore, the speaker wire should be checked.
 - If your car's ignition does not have an ACC position, connect the ignition wires to a power source that can be turned on and off with the ignition key. If you connect the ignition wire to a power source with a constant voltage supply, as with battery wires, the battery may die.
 - If the console has a lid, make sure to install the unit so that the faceplate will not hit the lid when closing and opening.
 - If the fuse blows, first make sure the wires aren't touching to cause a short circuit, then replace the old fuse with one with the same rating.
 - Insulate unconnected wires with vinyl tape or other similar material. To prevent a short circuit, do not remove the caps on the ends of the unconnected wires or the terminals.
 - Connect the speaker wires correctly to the terminals to which they correspond. The unit may be damaged or fail to work if you share the \ominus wires or ground them to any metal part in the car.
 - When only two speakers are being connected to the system, connect the connectors either to both the front output terminals or to both the rear output terminals (do not mix front and rear). For example, if you connect the \oplus connector of the left speaker to a front output terminal, do not connect the \ominus connector to a rear output terminal.
 - After the unit is installed, check whether the brake lamps, blinkers, wipers, etc. on the car are working properly.
 - Mount the unit so that the mounting angle is 30° or less.

Connecting Wires to Terminals

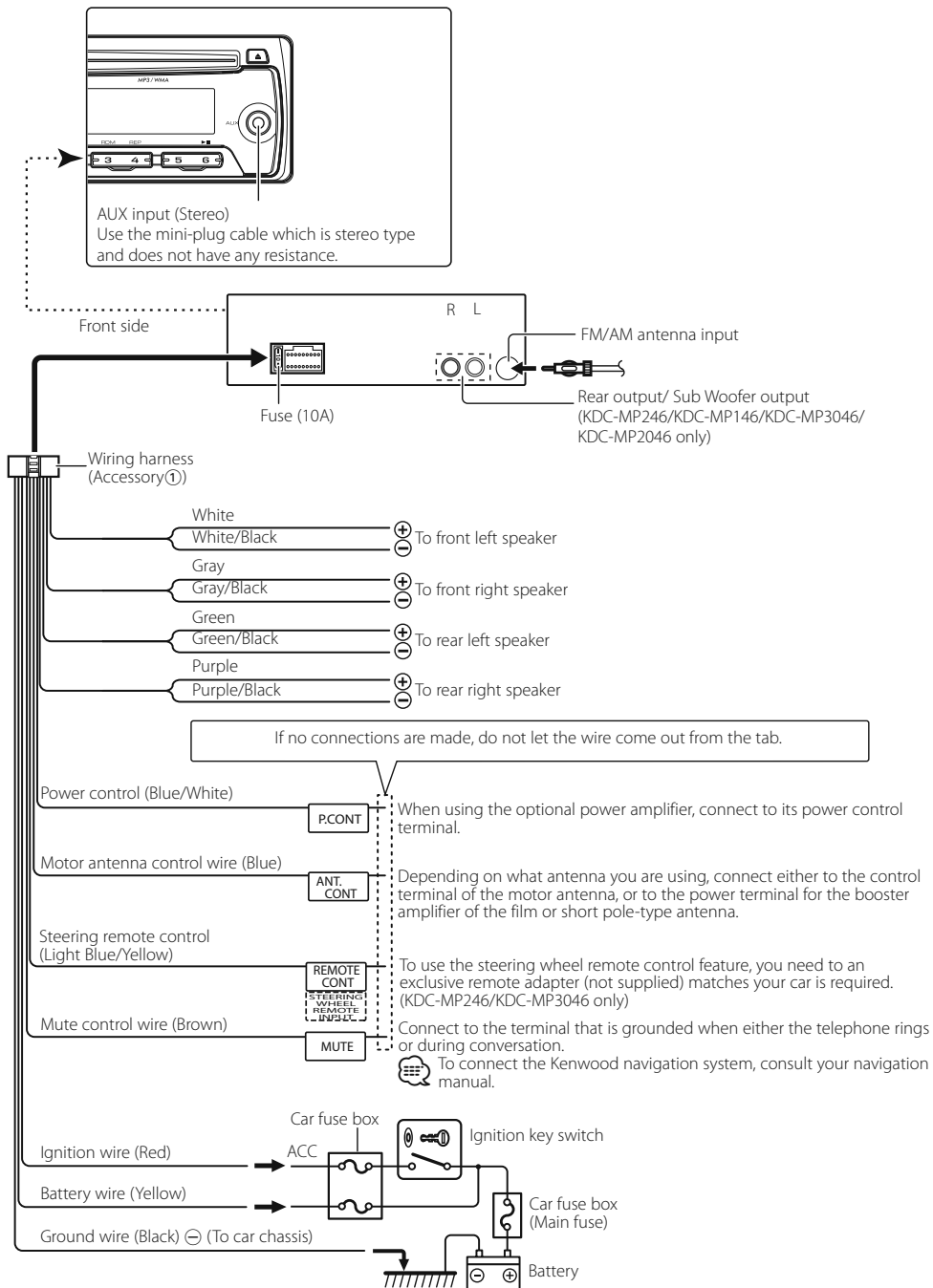

Installation/Removing the Unit

Non-Japanese Cars

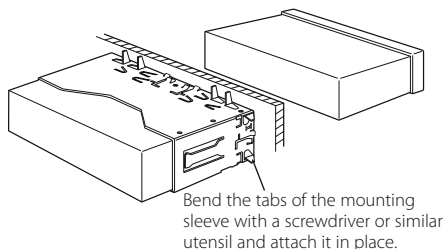

- Make sure that the unit is installed securely in place. If the unit is unstable, it may malfunction (for example, the sound may skip).

Japanese Cars

- 1 Refer to the section <Removing the Hard Rubber Frame> and then remove the hard rubber frame.
- 2 Align the holes in the unit (two locations on each side) with the vehicle mounting bracket and secure the unit with the accessory screws.

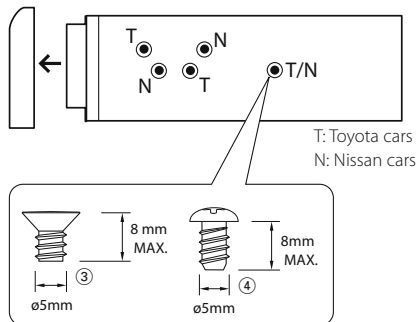

Accessory ③...for Nissan car
Accessory ④...for Toyota car

CAUTION

Install this unit in the console of your vehicle.
Do not touch the metal part of this unit during and shortly after the use of the unit. Metal part such as the heat sink and enclosure become hot.

Removing the Hard Rubber Frame

- 1 Engage the catch pins on the removal tool and remove the two locks on the upper level. Upper the frame and pull it forward as shown in the figure.

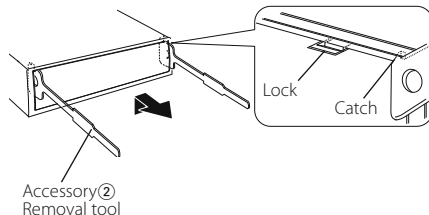

- 2 When the upper level is removed, remove the lower two locations.



- The frame can be removed from the bottom side in the same manner.

Removing the Unit

- 1 Refer to the section <Removing the Hard Rubber Frame> and then remove the hard rubber frame.
- 2 Detach the faceplate.
- 3 Insert the two removal tools deeply into the slots on each side, as shown.
- 4 Lower the removal tool toward the bottom, and pull out the unit halfway while pressing towards the inside.

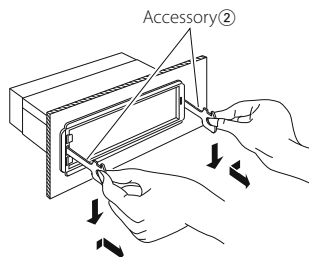

- Be careful to avoid injury from the catch pins on the removal tool.
- 5 Pull the unit all the way out with your hands, being careful not to drop it.

Troubleshooting Guide

Some functions of this unit may be disabled by some settings made on this unit.

- !** • **Cannot set up the subwoofer.**
 • **Cannot set up the low pass filter.**
 • **No output from the subwoofer.**
- ▶ • <Subwoofer output> of <Function Setting> (page 8) is not set to On.
 - Preout is not set to subwoofer. "SWITCH PRE" of <Function Setting> (page 8)

- !** **Cannot set up the subwoofer Phase.**
- ▶ Subwoofer Low Pass Filter is set to "THROUGH". "LPF SUB-W" of <Function Setting> (page 8)

- !** **Volume cannot be adjusted.**
- ▶ • The unit is set to Music Search mode. Cancel the Music Search mode. (page 12)
 - The unit is set to Function Setting mode. Cancel the Function Setting mode. (page 8)

What might seem to be a malfunction in your unit may just be the result of slight misoperation or miswiring. Before calling service, first check the following table for possible problems.

General

- ?** **The Touch Sensor Tone (beep sound) does not sound.**
- ✓ The preout jack is being used. The Touch Sensor Tone cannot be output from the preout jack.

Tuner source

- ?** **Radio reception is poor.**
- ✓ The car antenna is not extended. Pull the antenna out all the way.

Disc source

- ?** **The specified disc does not play, but another one plays instead.**
- ✓ The specified CD is quite dirty. Clean the CD, referring to the CD cleaning of the section on <Handling CDs> (page 3).
 - ✓ The disc is severely scratched. Try another disc instead.

Audio file source

- ?** **The sound skips when an Audio file is being played.**
- ✓ The media is scratched or dirty. Clean the media, referring to the CD cleaning of the section on <Handling CDs> (page 3).
 - ✓ The recording condition is bad. Record the media again or use another media.

The messages shown below display your systems condition.

TOC ERROR:	The CD is quite dirty. The CD is upside-down. The CD is scratched a lot.
ERROR 05:	The disc is unreadable.
ERROR 99:	The unit is malfunctioning for some reason. Press the reset button on the unit. If the "ERROR 99" code does not disappear, consult your nearest service center.
IN (Blink):	The CD player section is not operating properly. Reinsert the CD. If the CD cannot be ejected or the display continues to flash even when the CD has been properly reinserted, please switch off the power and consult your nearest service center.
PROTECT:	The speaker wire has a short-circuit or touches the chassis of the vehicle, and then the protection function is activated. Wire or insulate the speaker cable properly and press the reset button. If the "PROTECT" code does not disappear, consult your nearest service center.
NA FILE:	An Audio file is played with a format that this unit can't support.
COPY PRO:	A copy-protected file is played.
NO MUSIC/ERROR 15:	Media was played that does not have data recorded that the unit can play.

Specifications

FM tuner section

Frequency range
 200 kHz space
 : 87.9 MHz – 107.9 MHz
 50 kHz space
 : 87.5 MHz – 108.0 MHz
 Usable sensitivity (S/N = 26dB)
 : 11.2dBf (1 μ V/75 Ω)
 Quieting Sensitivity (DIN S/N = 46dB)
 : 19.2dBf (2.5 μ V/75 Ω)
 Frequency response (\pm 3 dB)
 : 30 Hz – 15 kHz
 Signal to Noise ratio (MONO)
 : 63 dB
 Stereo separation (1 kHz)
 : 40 dB

AM tuner section

Frequency range
 Band1 (MW) : 530 kHz – 1700 kHz (10 kHz space)
 : 531 kHz – 1611 kHz (9 kHz space)
 Band2 (SW1) : 2940 kHz – 7735 kHz (5 kHz space)
 Band3 (SW2) : 9500 kHz – 10135 kHz / 11580 kHz
 - 18135 kHz (5 kHz space)
 Usable sensitivity (S/N = 20dB)
 MW : 31 dB μ (36 μ V)
 SW : 32 dB μ (40 μ V)

CD player section

Laser diode
 : GaAlAs
 Digital filter (D/A)
 : 8 Times Over Sampling
 D/A Converter
 : 24 Bit
 Spindle speed
 : 500 – 200 rpm (CLV)
 Wow & Flutter
 : Below Measurable Limit
 Frequency response (\pm 1 dB)
 : 20 Hz – 20 kHz
 Total harmonic distortion (1 kHz)
 : 0.01 %
 Signal to Noise ratio (1 kHz)
 : 105 dB
 Dynamic range
 : 93 dB
 MP3 decode
 : Compliant with MPEG-1/2 Audio Layer-3
 WMA decode
 : Compliant with Windows Media Audio

Audio section

Maximum output power
 : 50 W x 4
 Full Bandwidth Power (at less than 1% THD)
 : 22 W x 4
 Speaker Impedance
 : 4 – 8 Ω
 Tone action
 Bass : 100 Hz \pm 8 dB
 Middle : 1 kHz \pm 8 dB
 Treble : 10 kHz \pm 8 dB
 Preout level / Load (CD) (KDC-MP246/KDC-MP146/
 KDC-MP3046/KDC-MP2046)
 : 2000 mV/10 k Ω
 Preout impedance (KDC-MP246/KDC-MP146/
 KDC-MP3046/KDC-MP2046)
 : \leq 600 Ω

Auxiliary input

Frequency response (\pm 3 dB)
 : 20 Hz – 20 kHz
 Input Maximum Voltage
 : 1200 mV
 Input Impedance
 : 10 k Ω

General

Operating voltage (11 – 16V allowable)
 : 14.4 V
 Maximum Current consumption
 : 10 A
 Installation Size (W x H x D)
 : 182 x 53 x 155 mm
 Weight
 : 2.9 lbs (1.3 kg)

Specifications subject to change without notice.



This symbol mark indicates that Kenwood manufactured this product so as to decrease harmful influence on the environment.